

REPÈRES CP

CAHIER 2 DE FRANÇAIS

PRÉNOM DE L'ÉLÈVE

NOM DE L'ÉLÈVE

CLASSE DE L'ÉLÈVE



Exercise 1



2	a	∩	↙
b	56	▴	→
↑	*	%	&
①	§	+	p



F	8	□	◀
∞	h	↖	⇒
↔	?	☞	m
↪	15	//	#

Exercice 1 (suite)



r

U



∞

26

\leq

N

\neq



\pm

\ominus

\mathcal{L}



B

154



!

3



F

E

Exercice 1 (suite)



R



L



5



S



Exercise 2

VPO VPO

~~LKNB LKFB~~

~~JMB MJB~~



GPD CPD

TGR TGR

GHIJ GHIJ

CGNMO CGNMO

BRT BTR

POJZB POJZB

BGTR BCTR

DFEK DEFK

QZM QZM

MZV MZV

SRGVT SRCVT

ZPLC ZPLC

OZCP OZCP

LKFTZ LKFTZ

HXF HXE

DHRST DHRST

LDF DLF

FGTLM FGTLM

VCQF VCOF

ITRF IRTF

ITK ITK

MOVGB MQVGB

PEFD PEFD

PXOVT PXVOT

Exercice 3

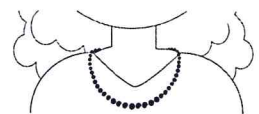
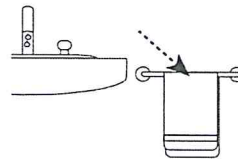
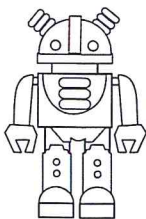
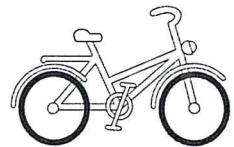
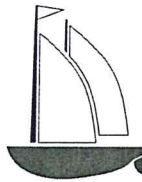
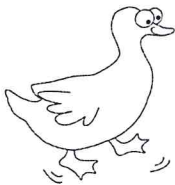
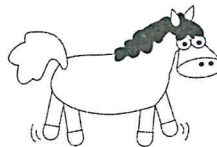
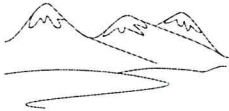
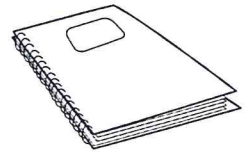
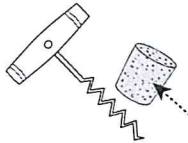
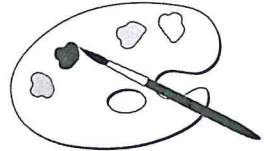
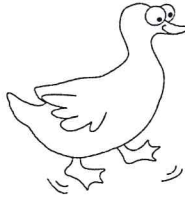
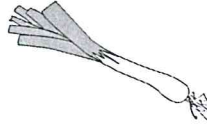
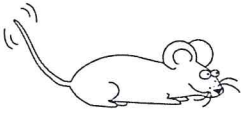

Exercice 3 (suite)

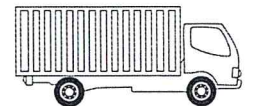
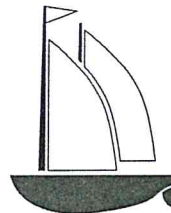
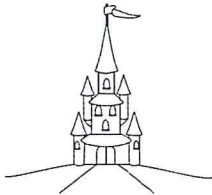
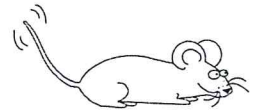
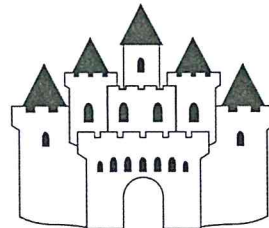
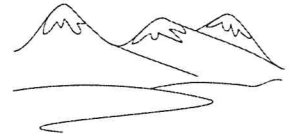
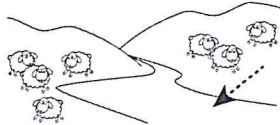
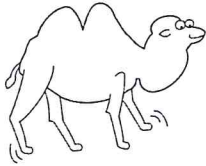
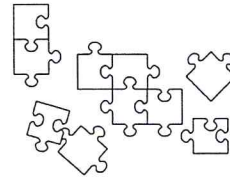
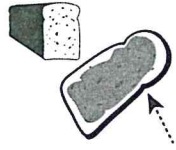

Exercice 4

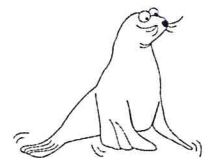
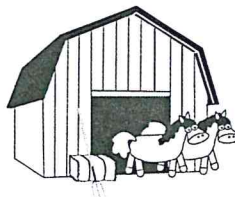
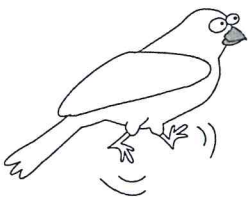
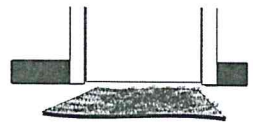
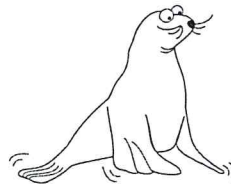
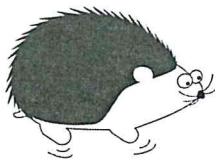
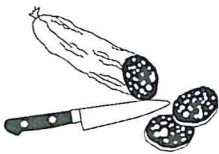
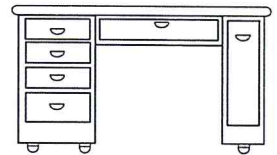
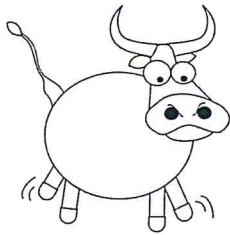
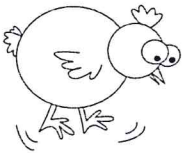
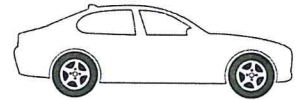
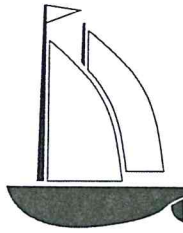
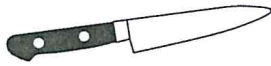
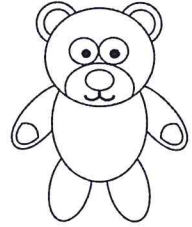
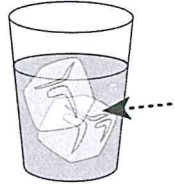
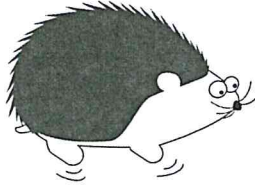
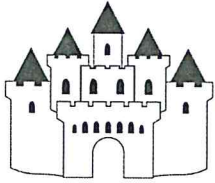
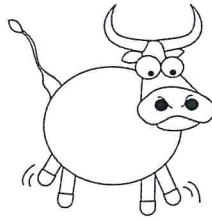
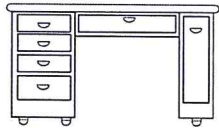
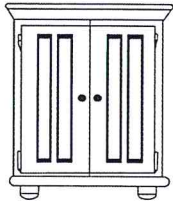

Exercice 5

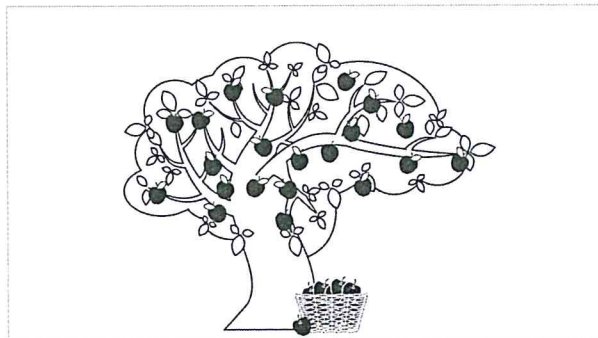
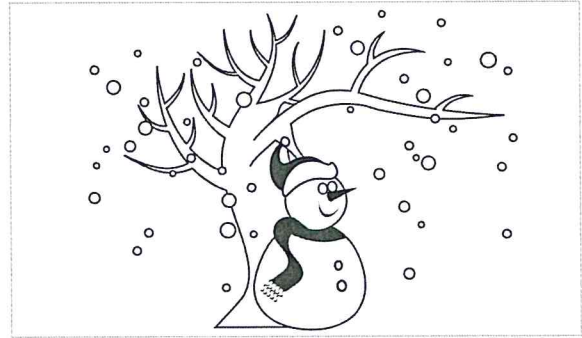
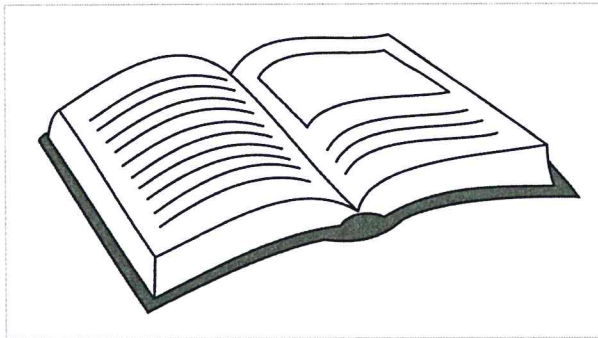
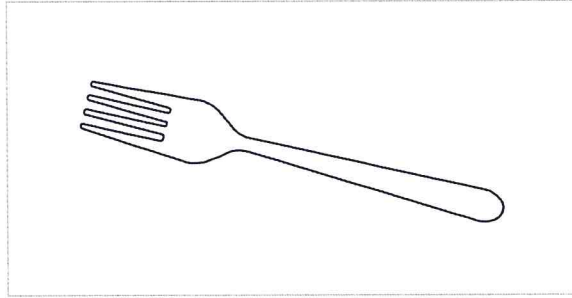
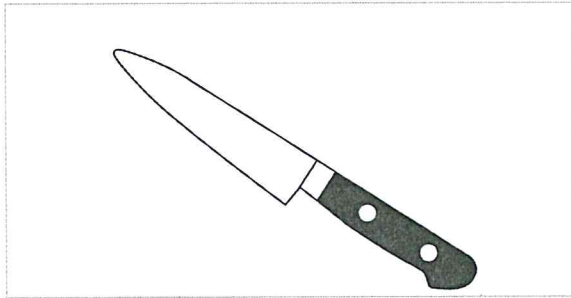
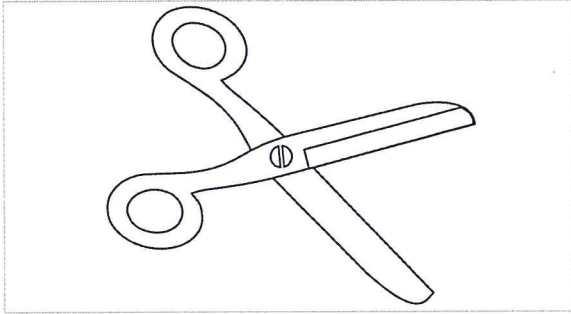

Exercice 5 (suite)

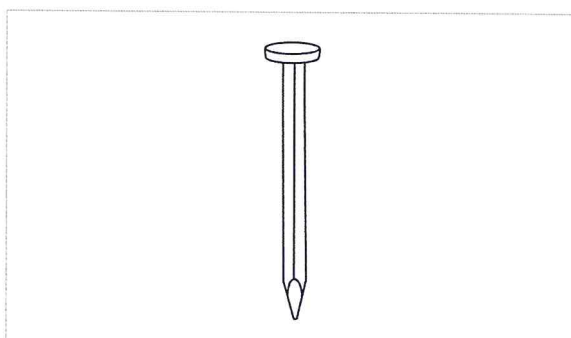
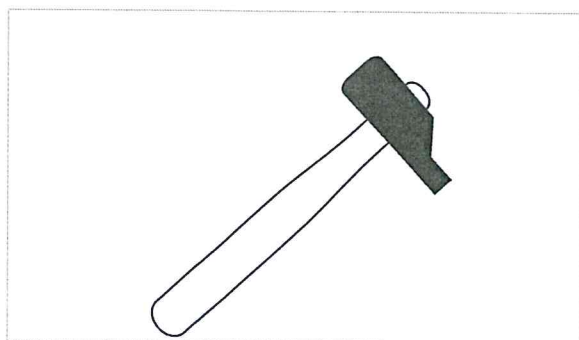
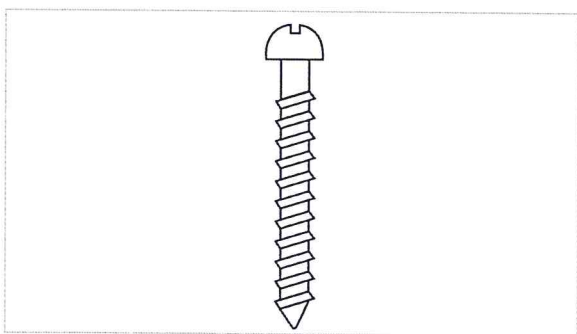
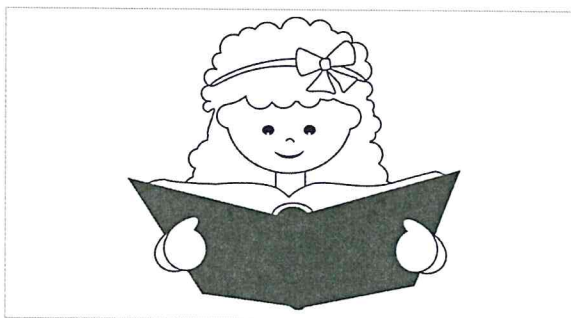
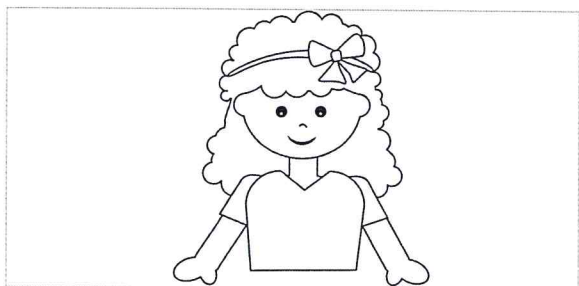

Exercice 5 (suite)

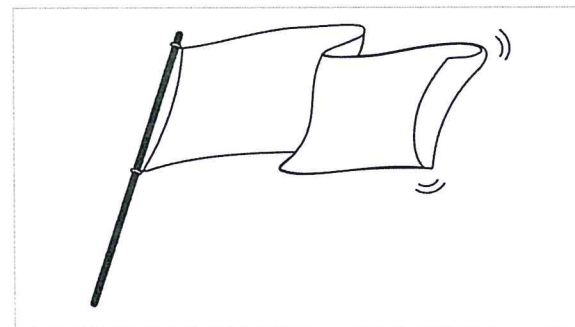
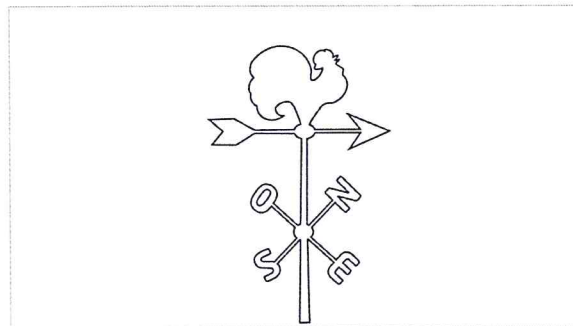
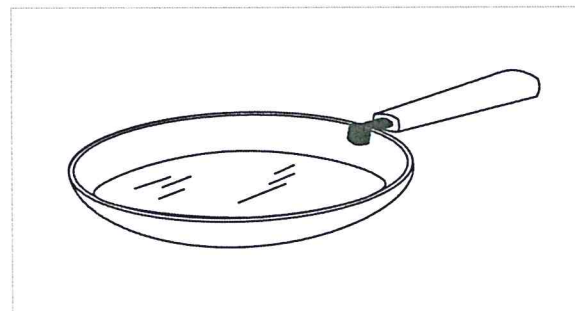
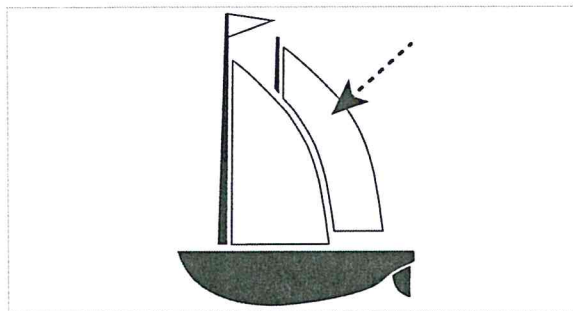
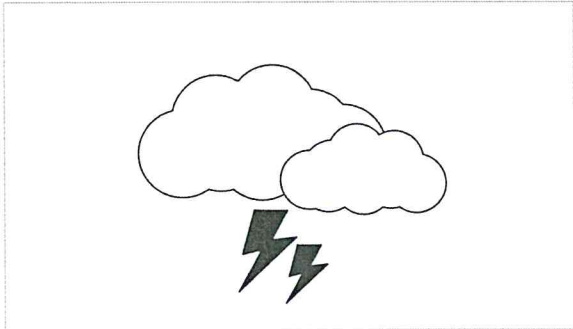
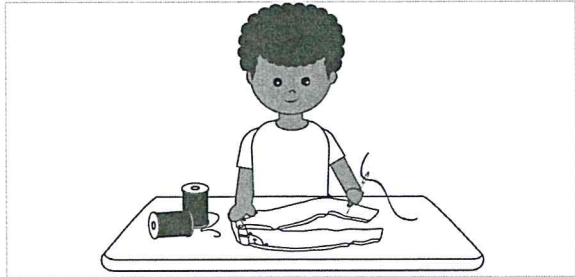
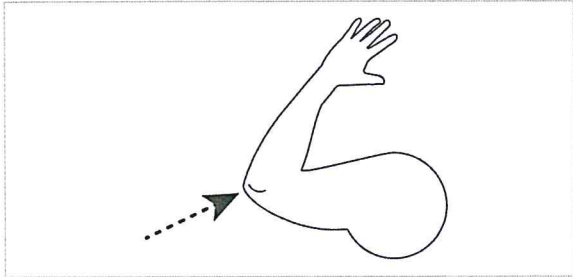

Exercice 5 (suite)

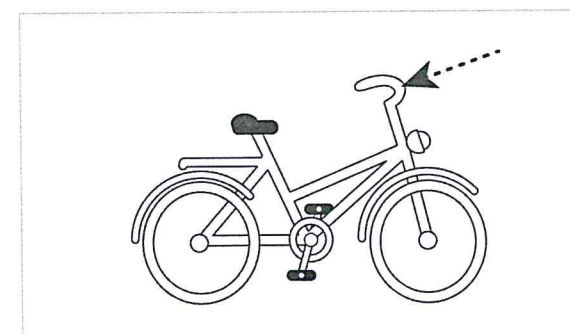
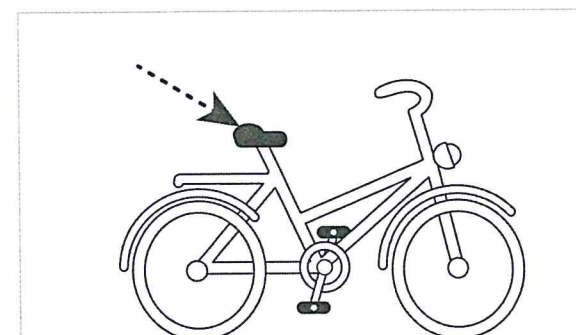
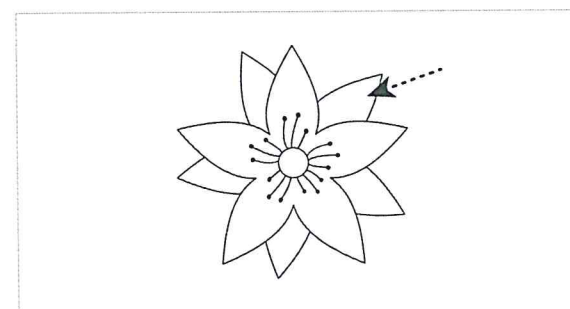
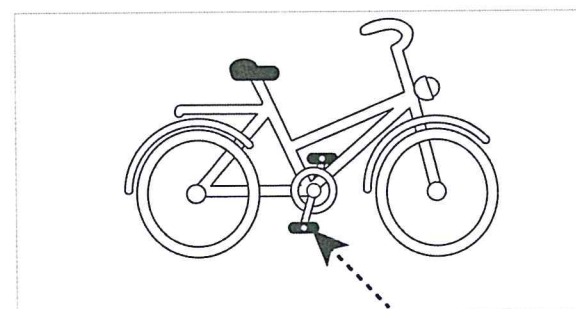
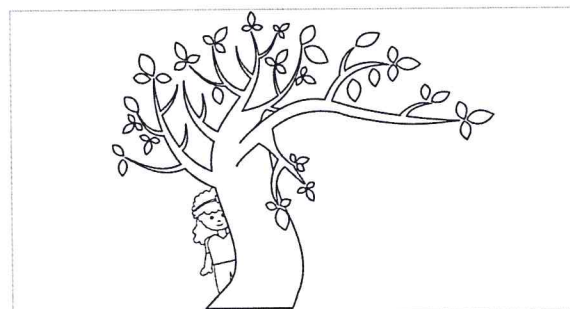
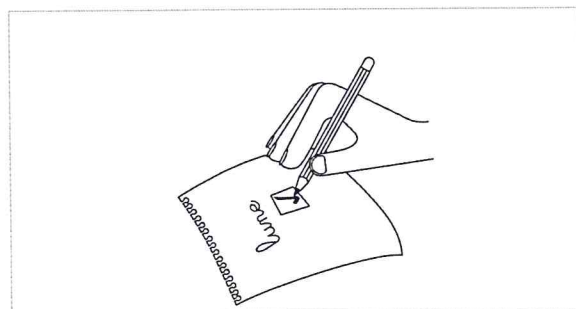
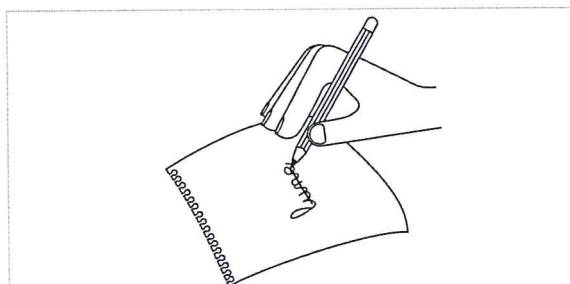
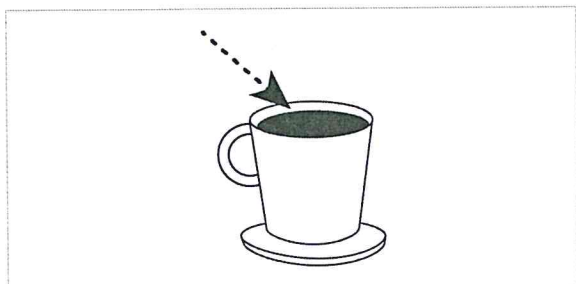

Exercice 5 (suite)

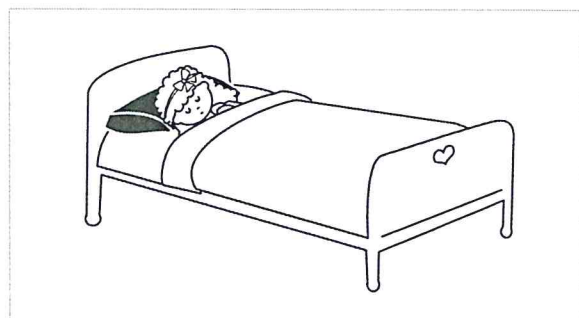
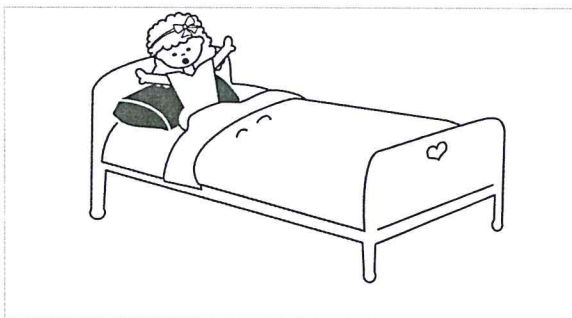
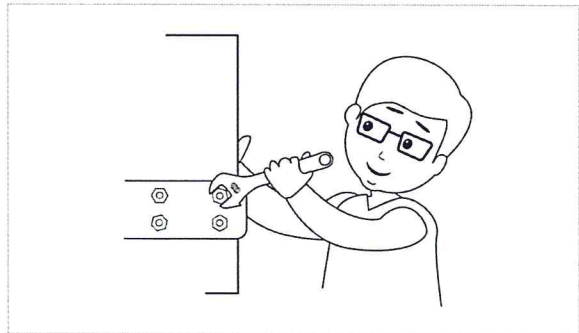
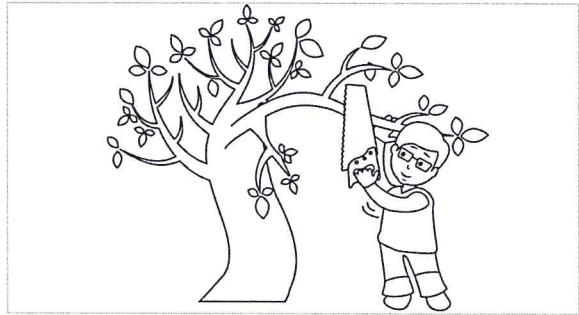
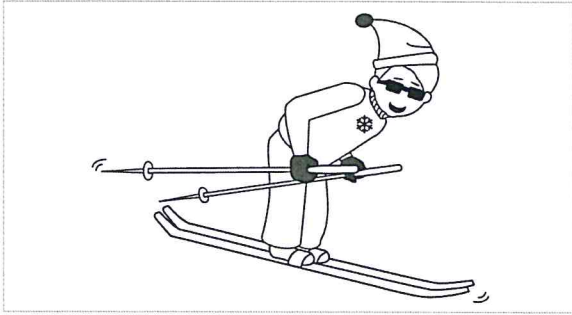

Exercice 5 (suite)

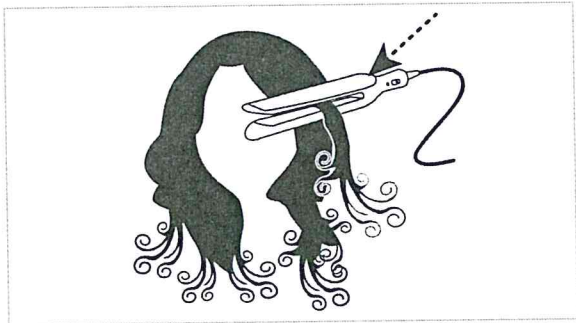
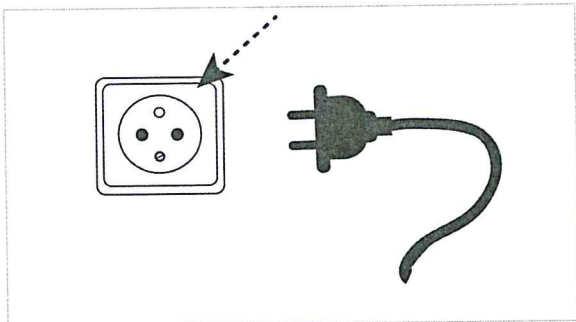
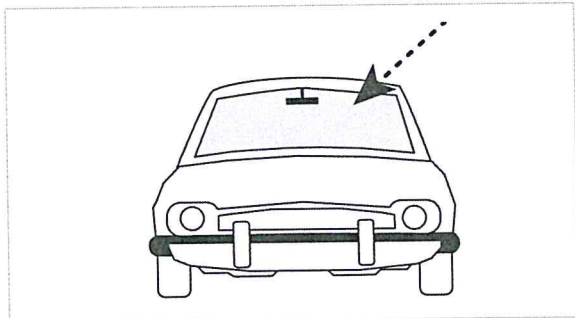
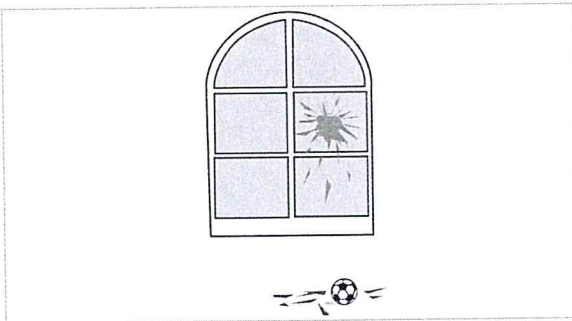
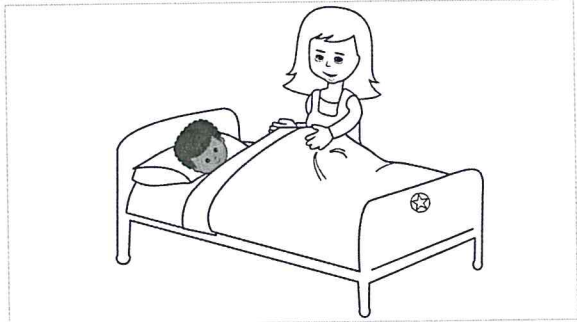
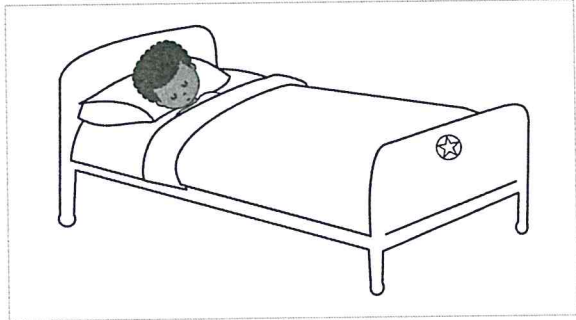

Exercice 5 (suite)

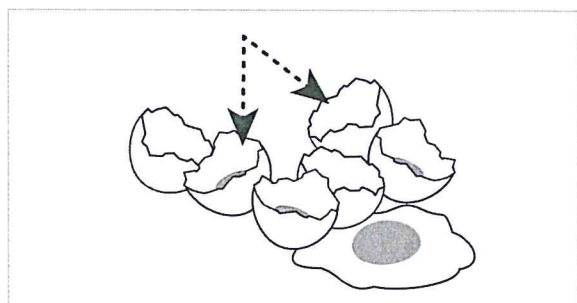
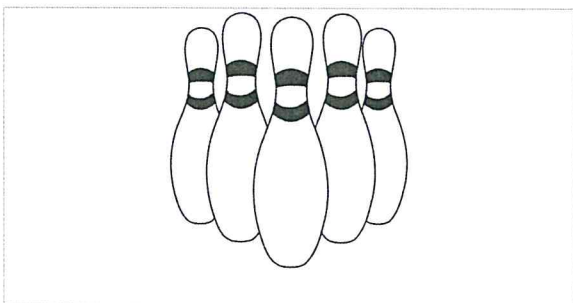
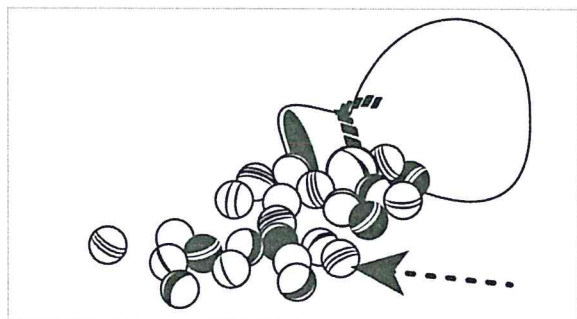
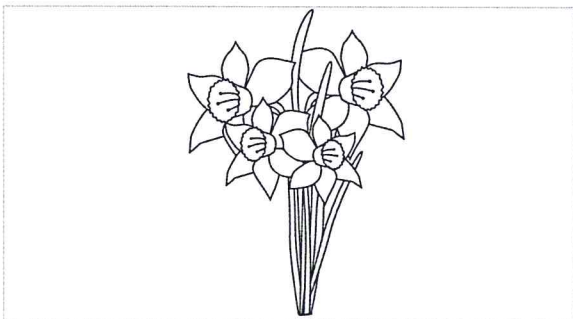
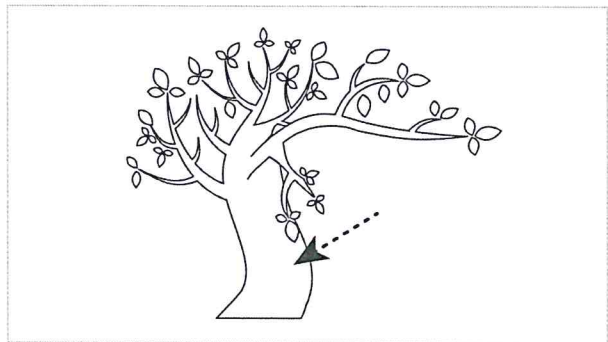
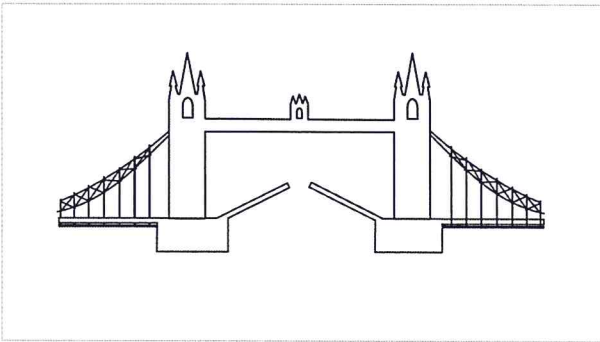
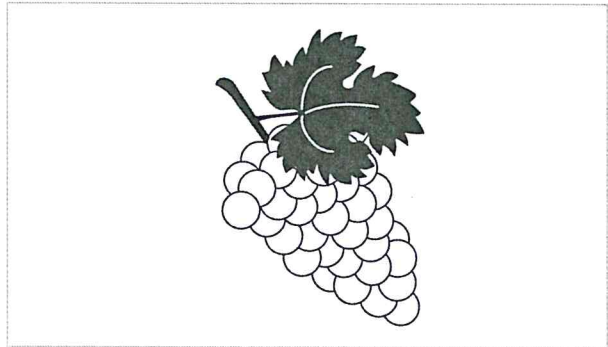
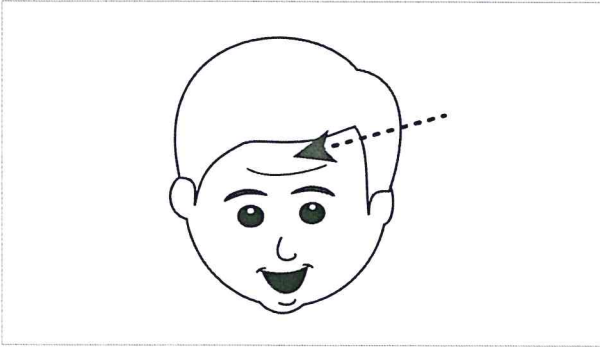

Exercice 5 (suite)

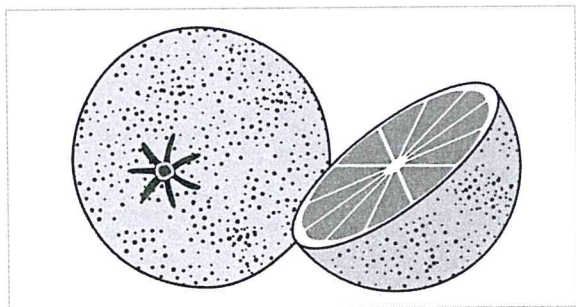
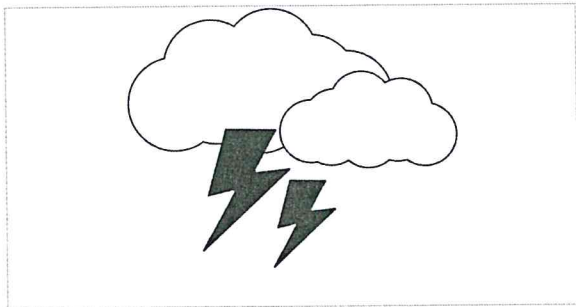
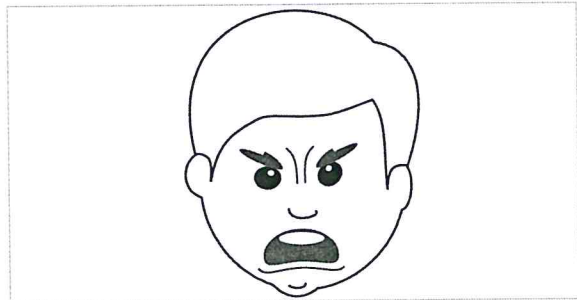
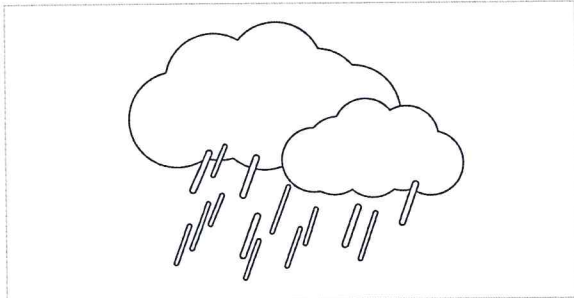
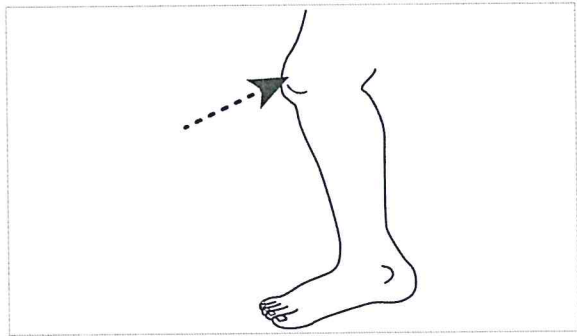
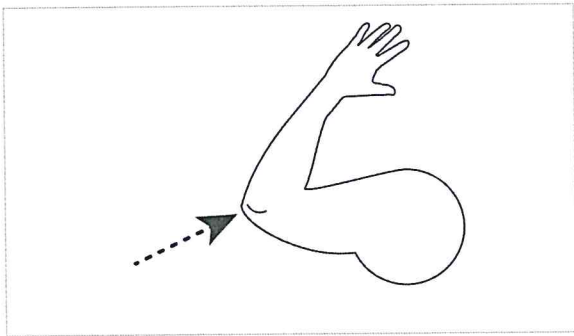
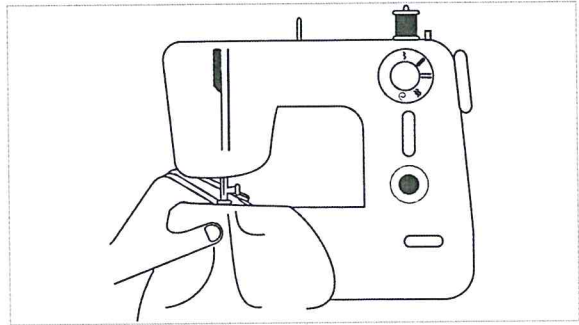
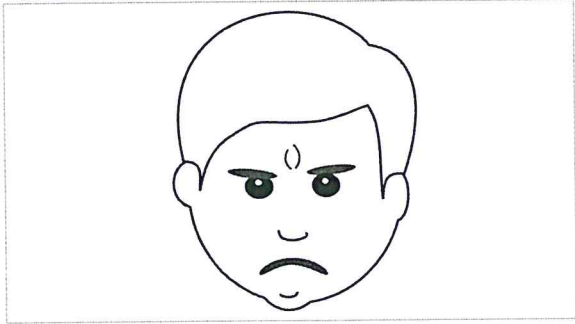

Exercice 6

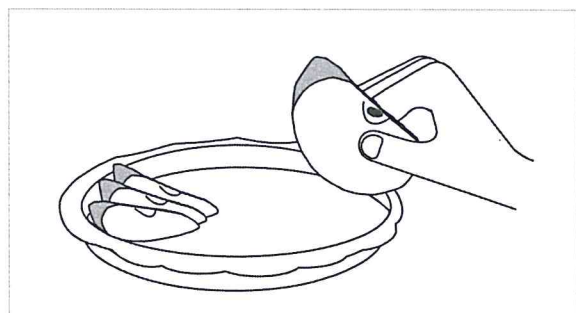
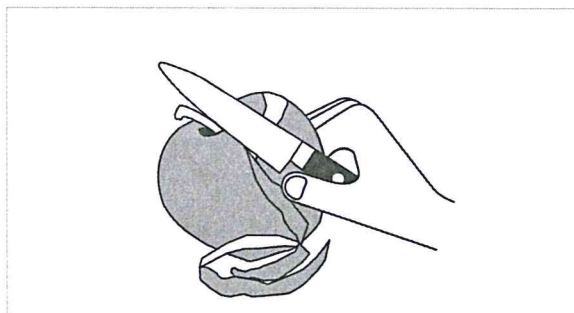
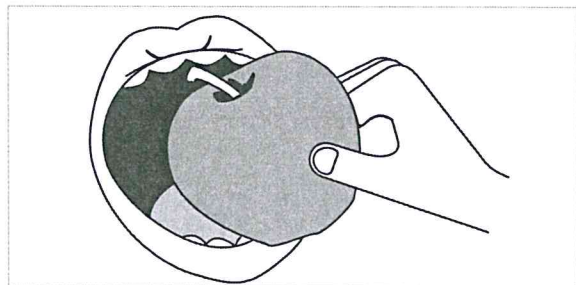
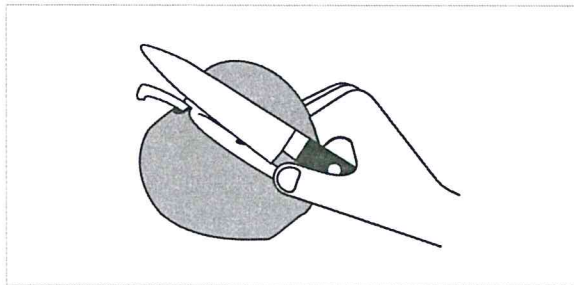
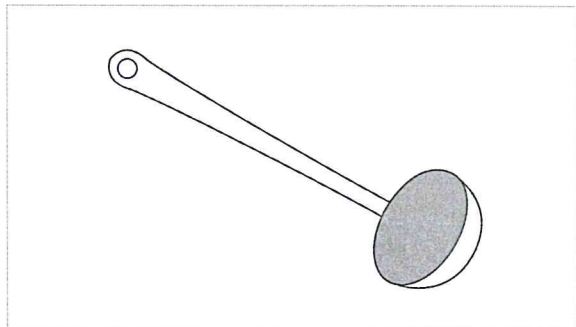
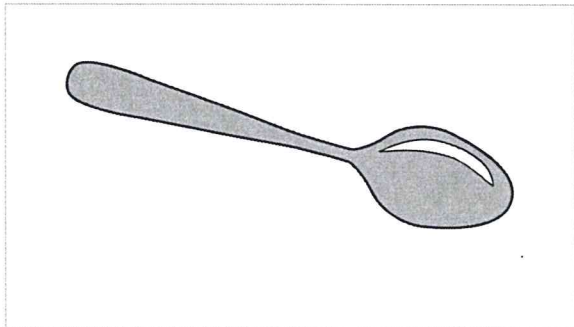
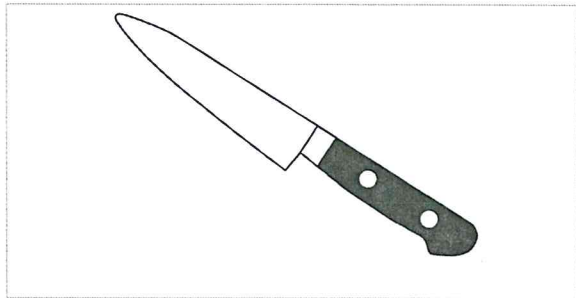
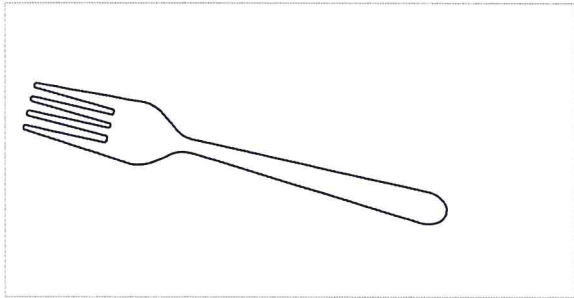

Exercice 6 (suite)

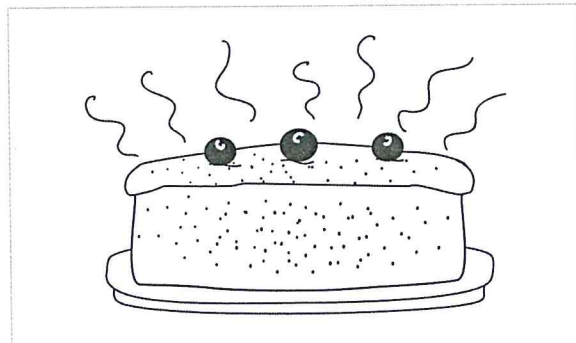
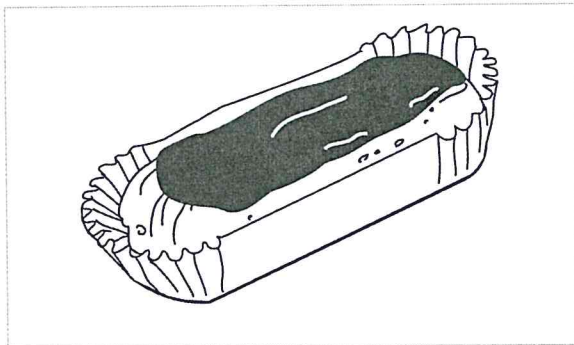
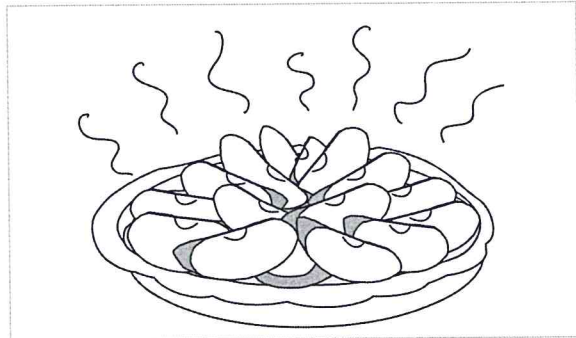
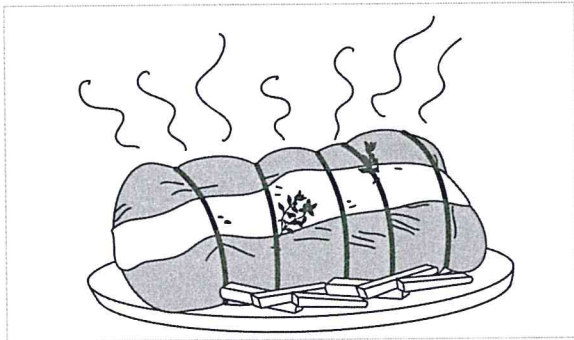
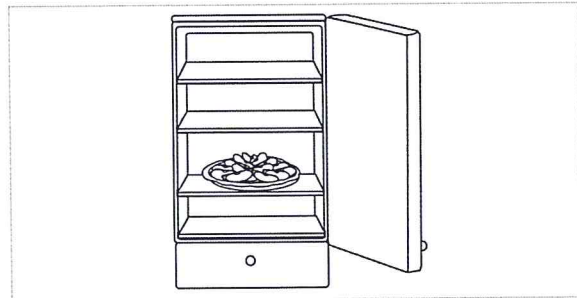
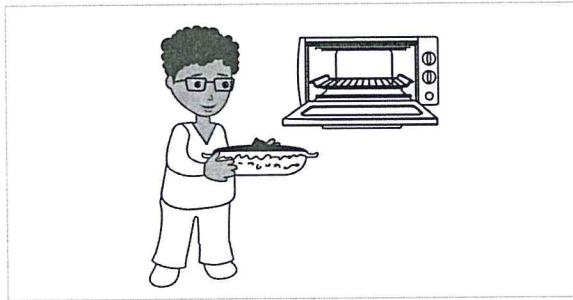
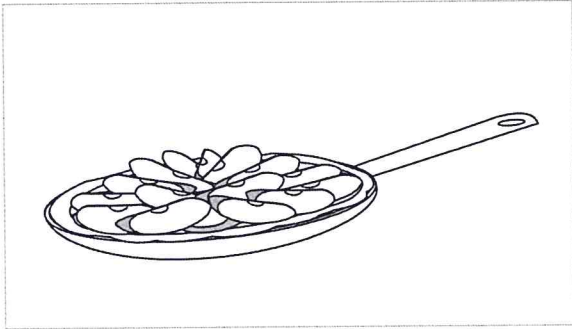

Exercice 7

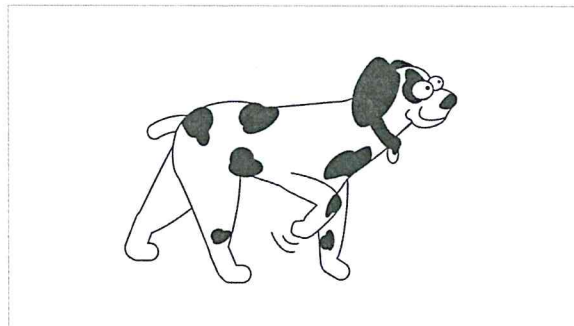
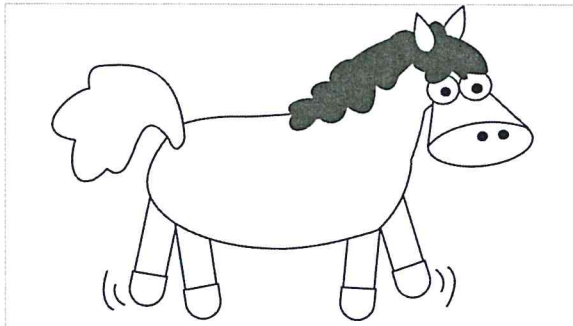
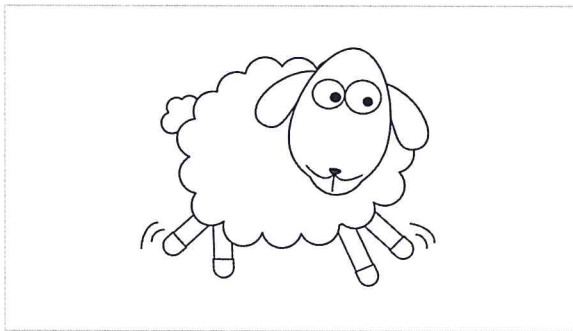
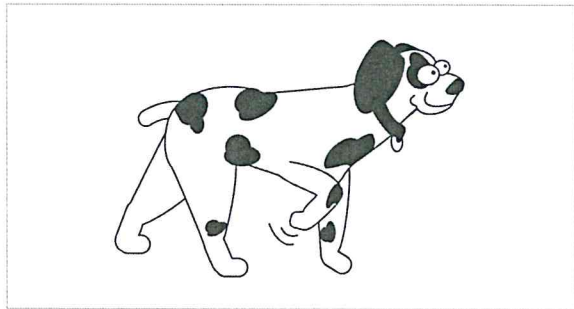
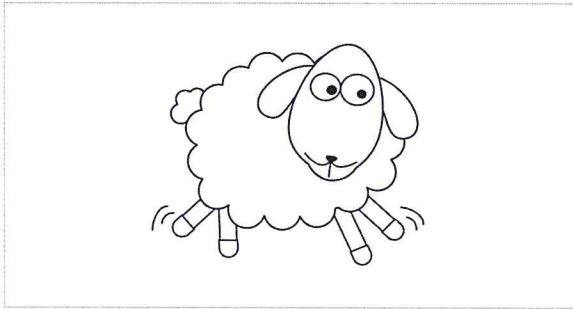
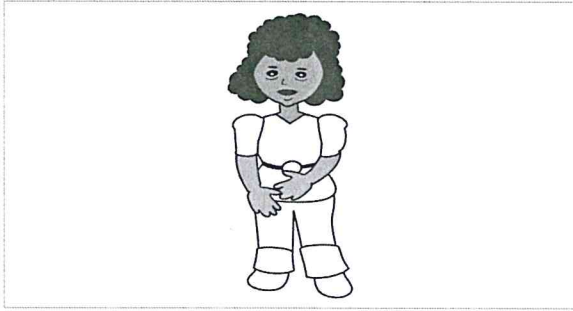

Exercice 7 (suite)

